



 LOS DI

STAR *PRO*

NUESTRA NUEVA LÍNEA  
OUR NEW LINE  
NOTRE NOUVELLE LIGNE

# STAR PRO

**(ESP)** Hecha a partir de polipropileno, un material ligero, flexible y sostenible, dado que lleva un 30% menos de plástico, su diseño minimalista le brinda un aspecto sencillo, pero a su vez orgánico y futurista. Una línea moderna que se adapta a todos los espacios.

**(ENG)** Made from polypropylene, a light, flexible and sustainable material, with 30% less plastic, its minimalist design gives it a simple aspect, but at the same time organic and futuristic look. A modern line that adapts to all spaces.

**(FR)** Fabriqué en polypropylène, un matériau léger, flexible et durable, avec 30% moins de plastique, son design minimaliste lui confère un aspect simple, mais organique et futuriste. Une ligne moderne qui s'adapte à tous les espaces.





# DISPENSADORES DE JABÓN

SOAP DISPENSERS / DISTRIBUTEURS DE SAVON

## CJ-6103-B / CJ-6104-B / CJ-6105-B



Ref.

Capacidad  
capacity  
capacité

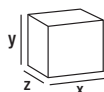

Sistema  
system  
système

Jabón  
soap  
savon

Unidades palé  
pallet units  
unités palette

CP-6103-B  
CP-6104-B  
CP-6105-B

850 ml.  
850 ml.  
750 ml.

x 153 mm.  
y 221 mm.  
z 117 mm.

Rellenable / refillable / rechargeable  
Rellenable / refillable / rechargeable  
Cargas / cartridge / recharges

Líquido / liquid / liquide  
Espuma / foam / mousse  
Líquido o espuma / liquid or foam / liquide or mousse

336



# DISPENSADORES DE PAPEL HIGIÉNICO

TOILET PAPER DISPENSERS / DISTRIBUTEURS DE PAPIER HYGIÉNIQUE

DISPENSACIÓN CONTROLADA / **CP-6100-B**  
CONTROLLED DISPENSING /  
DISTRIBUTION CONTRÔLÉE



Ref.

**Medidas del papel**  
paper measurements  
dimensions du papier

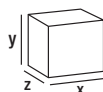

**Unidades palé**  
pallet units  
unités palette

CP-6100-B

190 mm. <math>\varnothing</math> <math>< 208</math> mm.  
Altura / height / hauteur 110 mm.  
Longitud servicio / service length / longueur service  
250 - 300 mm.

x 284 mm.  
y 284 mm.  
z 170 mm.

108

# DISPENSADORES DE PAPEL HIGIÉNICO

TOILET PAPER DISPENSERS / DISTRIBUTEURS DE PAPIER HYGIÉNIQUE

## JUMBO CP-6106-B



Ref.	Cánula cannula canule	Medidas del papel paper measurements dimensions du papier		Unidades palé pallet units unités palette
CP-6106-B	Ø 45 mm.	Ø max. 210 mm. Altura / height / hauteur 110 mm.	x 253 mm. y 253 mm. z 151 mm.	108



# DISPENSADORES DE PAPEL HIGIÉNICO

TOILET PAPER DISPENSERS / DISTRIBUTEURS DE PAPIER HYGIÉNIQUE

## MAXI JUMBO CP-6107-B



Ref.

Cánula  
cannula  
canule

Medidas del papel  
paper measurements  
dimensions du papier

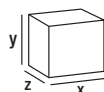

Unidades palé  
pallet units  
unités palette

CP-6107-B

Ø 56 mm.

Ø max. 270 mm.  
Altura / height / hauteur 110 mm.

x 318 mm.  
y 318 mm.  
z 155 mm.

108

# DISPENSADORES DE PAPEL MECHA

CENTERFEED PAPER DISPENSERS / DISTRIBUTEURS DE PAPIER À DÉVIDAGE CENTRAL

## CP-6110-B / CP-6111-B



CP-6110-B

CP-6111-B

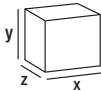
Ref.	Capacidad capacity capacité		Sistema system système	Unidades palé pallet units unités palette
CP-6110-B CP-6111-B	Ø max. 205 mm. Altura / height / hauteur 245 mm.	x 267 mm. y 350 mm. z 237 mm.	Dispensación continua continuous dispensing distribution continue  Dispensación controlada controlled dispensing distribution contrôlée	75



# DISPENSADORES DE PAPEL TOALLA

PAPER TOWEL DISPENSERS / DISTRIBUTEURS D'ESSUIE-MAINS

## CP-6109-B



**Ref.**

**Capacidad**  
capacity  
capacité

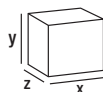

**Unidades palé**  
pallet units  
unités palette

CP-6109-B

600 unidades / units / unité  
Papel / paper / papier  
max. 110 x 240 mm.

x 325 mm.  
y 374 mm.  
z 146 mm.

96

# DISPENSADORES DE PAPEL TOALLA

PAPER TOWEL DISPENSERS / DISTRIBUTEURS D'ESSUIE-MAINS

## AUTOCUT CP-6525-B



Ref.

Cánula  
cannula  
canule

Capacidad  
capacity  
capacité

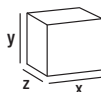

Unidades palé  
pallet units  
unités palette

CP-6525-B

Ø 36 mm.

Ø max. 205 mm.  
Anchura / width / largeur  
200 - 210 mm.

x 280 mm.  
y 378 mm.  
z 229 mm.

60



STAR PRO

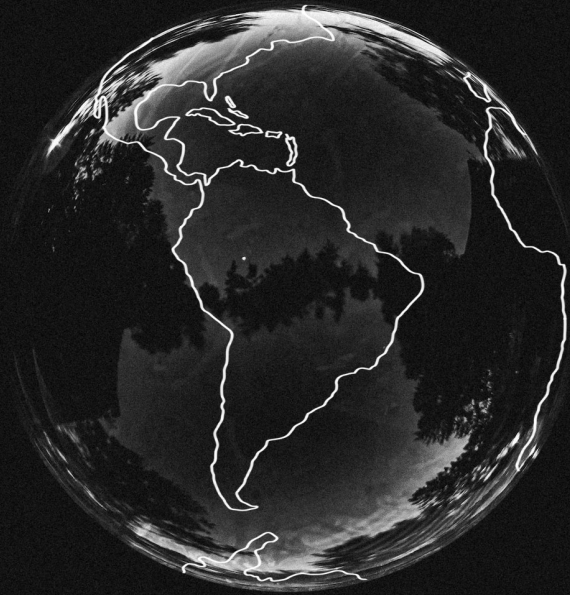



**D** Polígono Industrial Sur Santiago Payá  
C/ Filà Domingo Miques , 4 03801 , Alcoy (Alicante)  
Apartado de Correos 350 **SPAIN**

**T** (+34) 966 540 710 **E** [comercial@losdi.com](mailto:comercial@losdi.com)

**W** [losdi.com](http://losdi.com)



**( ) LOSDI**  
CLOSE TO YOU